

New perspectives for your research



ZEISS Axio Observer

Your open and flexible inverted microscope platform
with AI assisted experiment startup

zeiss.com/axio-observer



Seeing beyond

Your open and flexible inverted microscope platform

- › In Brief
- › The Advantages
- › The Applications
- › The System
- › Technology and Details
- › Service

In life sciences research you come up against new challenges every day – challenges that call for reproducible data from a whole range of samples in a variety of conditions. That's why you want a flexible microscope system that can be tailored to your needs, offering you lots of interfaces and extensions.

Axio Observer is your stable inverse platform for demanding multimodal imaging of living and fixed specimens. Featuring the AI Sample Finder for optimal user guidance and efficient operation, Axio Observer makes sample placement easier than ever and reduces the time to your experiments significantly. The platform uses the latest generation of LED illumination for gentle imaging and creates the optimal environment for a whole range of samples to deliver reliable, reproducible data. You can combine Axio Observer with a wealth of technologies and refine it to support your experiments precisely, choosing from a broad portfolio of options.

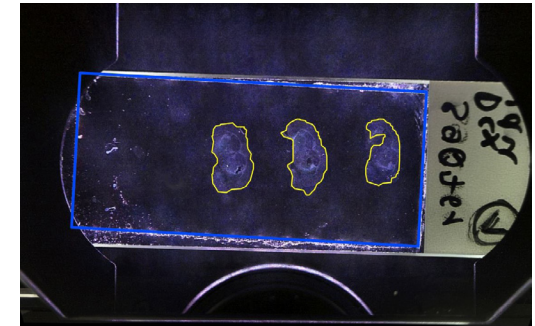

The AI Sample Finder identifies your sample carrier and detects sample areas automatically. Sample courtesy of M. Schmidt, Institute of Anatomy, Medical Faculty Carl Gustav Carus, TU Dresden, Germany.



Simpler. More Intelligent. More Integrated.

- › In Brief
- › **The Advantages**
- › The Applications
- › The System
- › Technology and Details
- › Service

Flexibility for your research

Life sciences research is a dynamic environment in which your imaging requirements are always changing. As your needs grow, Axio Observer stays with you step by step. It offers an abundance of interfaces for technologies ranging from widefield transmitted light to convenient 3D sectioning with Apotome 3, and sensitive super-resolution imaging with Elyra 7 or LSM 980 and Airyscan 2. Choose the optimal incubation equipment and enjoy easy sample access for precise micromanipulation. A great variety of integrated options makes your Axio Observer both versatile now and entirely future proof.



Guidance for your workflows

You will be amazed how easy imaging becomes when the AI Sample Finder automatically detects the sample carrier, adjusts the focus, and finds your sample region. Even with low-contrast samples, you will quickly obtain an overview image to access relevant regions with just a click. Reduce the time to image from minutes to just seconds and start your experiment right away. Let Smart Setup and the Focus Strategy Wizard guide you through the experimental setup for easy and intuitive selection of the imaging modalities for your applications. Using ZEN Connect, acquired images can be easily combined with electron microscopy data and other modalities.

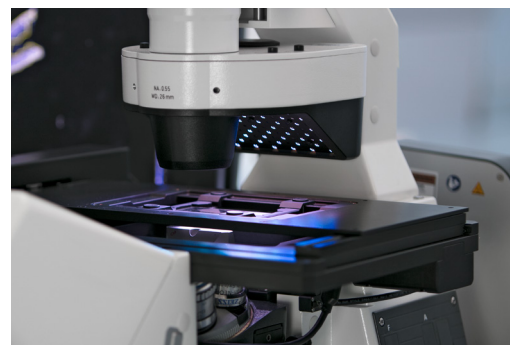

Efficiency for your experiments

Expect a remarkable increase in efficiency with the automation functions of Axio Observer. Use fast switchable LEDs or go for powerful and economic white-light sources in combination with the fast filter wheel for highest spectral flexibility and speed. Select the ideal camera from the dedicated ZEISS AxioCam portfolio or from third-party suppliers: You will always get the image quality and speed your applications require. With Definite Focus 3, focus drift during complicated experiments is a thing of the past. Whether keeping your sample in focus for long-term imaging or adapting your objective to your sample, it's all automatic with this highly organized system.



Your Insight into the Technology Behind It

- › In Brief
- › **The Advantages**
- › The Applications
- › The System
- › Technology and Details
- › Service

AI Sample Finder: Automated sample identification for efficient imaging

Microscopes are becoming increasingly automated. For sample placement, however, microscope parts such as the condenser arm often have to be moved manually. Focus adjustment and identification of the relevant areas on the sample carrier require additional manual steps.

The AI Sample Finder automates this sequence, eliminating time-consuming manual adjustments and reducing the time to image from minutes to just seconds.

You can access all sample areas directly which allows you starting your experiment faster than ever. The AI Sample Finder greatly improves productivity as you can easily image only those regions containing sample not overlooking potentially important areas.



- After you placed the sample on the loading position, the AI Sample Finder automatically moves it to the objective.



- Without the need of manual sample positioning or focusing, an overview image for fast and convenient navigation is taken within seconds. Composite darkfield illumination creates a high-contrast image even for very low-contrast samples.

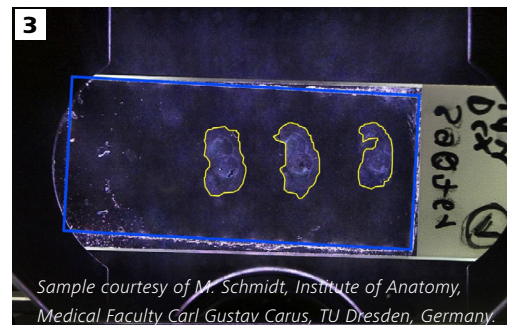

- Intelligent routines automatically identify your sample carrier, regardless if you use a petri dish, a chamber slide, or a multiwell plate. Carrier properties are automatically transferred to the software, eliminating manual settings.

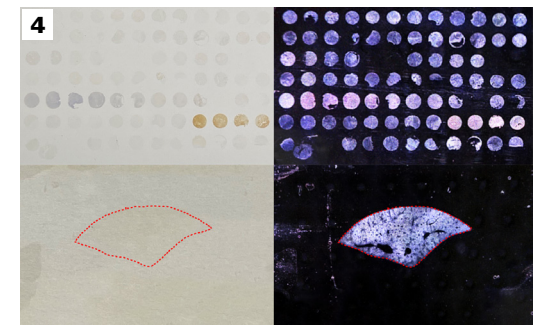

- Your samples are reliably identified. Deep Learning algorithms precisely detect even unusual sample regions. You can navigate and access all sample areas directly which allows you starting your experiment faster than ever.

Your Insight into the Technology Behind It

- › In Brief
- › **The Advantages**
- › The Applications
- › The System
- › Technology and Details
- › Service

See your entire sample for simple and fast navigation – with the AI Sample Finder

In science you never do an experiment only once. Statistics and controls are important to gain confidence and to verify conclusions. For interpretation of your results it's important to know additional information like the surrounding environment. A good overview image is the foundation for a detailed analysis. The AI Sample Finder enables you to see your entire sample with unmatched speed and ease of use. With ZEN Connect you can visualize your data in a higher context combining different imaging modalities like electron and light microscopy.

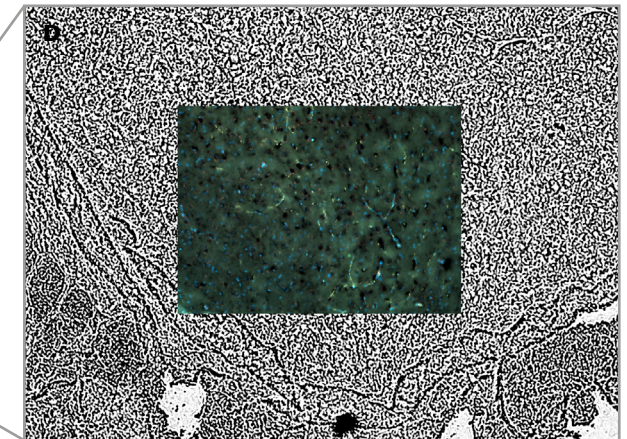
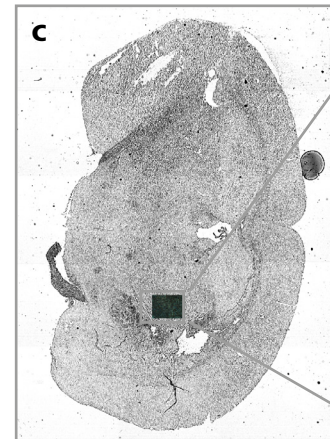
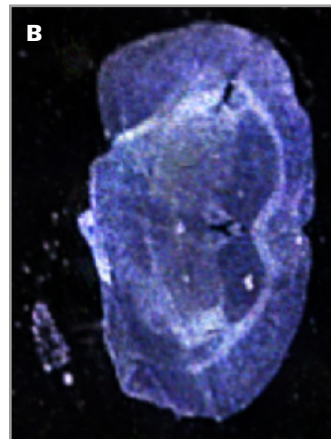
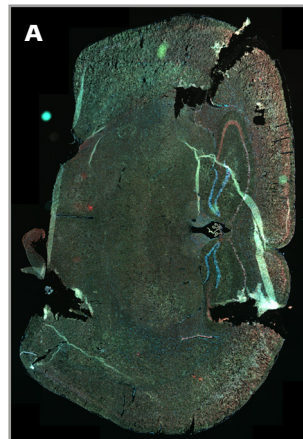
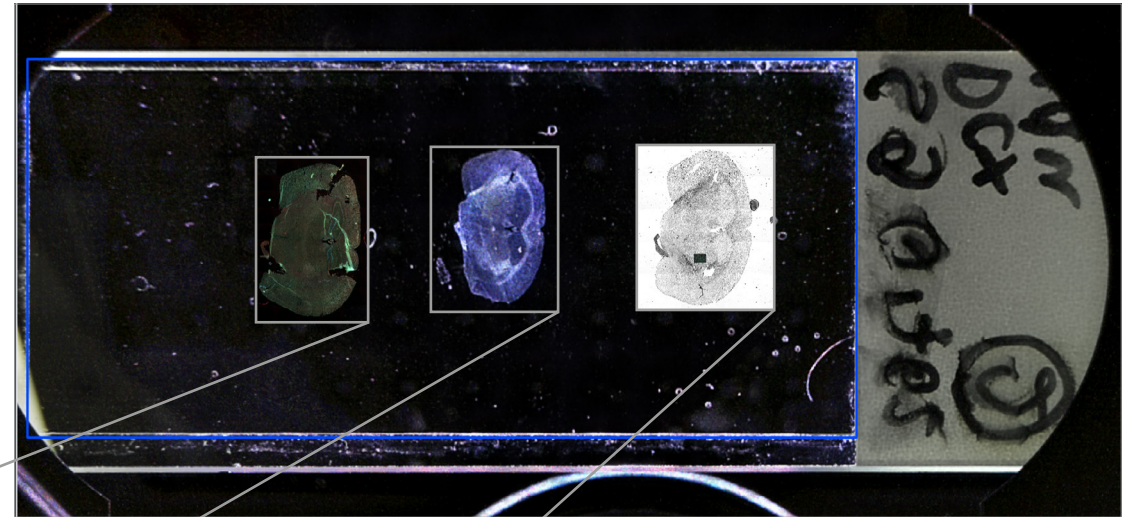

The overview image provided by the AI Sample Finder is ideally suited for navigation and orientation. You can use additional imaging modalities like fluorescence (A) to overlay the Darkfield Composite Contrast image (B) of the AI Sample Finder. Other methods like the Coherence Contrast (C) or a combination of fluorescence and Coherence Contrast (D) are possible, too. Forget about assignment issues after image acquisition. With the AI Sample Finder you always know in which sample region your experiment was conducted and how the surrounding environment looked like. Sample courtesy of M. Schmidt, Institute of Anatomy, Medical Faculty Carl Gustav Carus, TU Dresden, Germany.

Your Insight into the Technology Behind It

- › In Brief
- › **The Advantages**
- › The Applications
- › The System
- › Technology and Details
- › Service

Get better images – with Autocorr objectives

It takes the very best objectives with a high numerical aperture to image subcellular structures. But the wide opening angle of these objectives makes them especially susceptible to spherical aberrations. This physical effect is caused by the different refractive indices and interfaces in both the optical system and the sample. With the introduction of Autocorr, your Axio Observer now supports a new generation of objectives.

With Autocorr you adjust the optics of your microscope to your sample, with a simple slider in ZEN imaging software. Expect crisp contrast even deep inside in your specimen. And with greatly improved fluorescence detection, you will get better data while less excitation intensity will improve the viability of you samples.

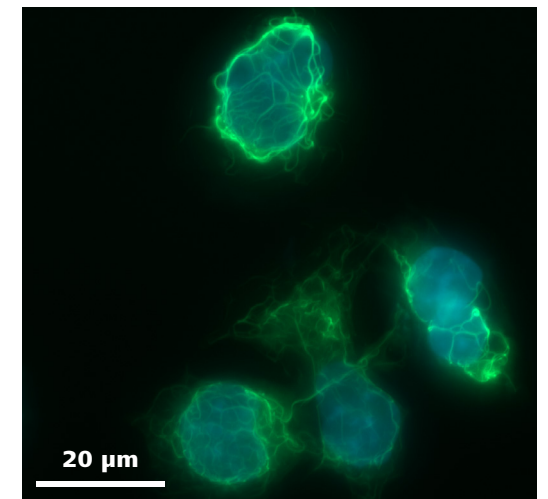
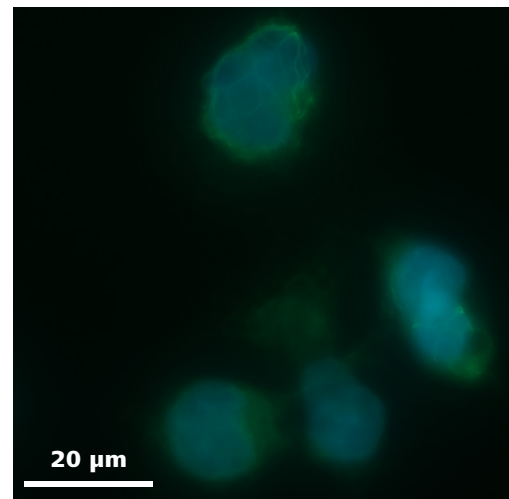

SK8 K18 mouse cells. Vimentin stained with Alexa 488 (green), nuclei stained with DAPI (blue). Left image without correction of cover slip thickness, right with applied correction.

Your Insight into the Technology Behind It

- › In Brief
- › **The Advantages**
- › The Applications
- › The System
- › Technology and Details
- › Service

Keep a sharp eye on your goals – with Definite Focus 3

Acquiring time-lapse data from living samples can be tricky. Changing conditions such as room temperature influence the microscope as well as the sample carrier and can cause focus drift.

Definite Focus 3 compensates for this drift and keeps your samples in focus. With higher accuracy and precision even your most challenging

multi-day, multi-position time-lapse experiments will yield sharp and high contrast images.

Here's how it works: an infrared LED is projected through a grid onto the bottom of the sample carrier. Any change in the focal position of the sample will be indicated by a change of the grid image on the carrier bottom. An integrated

camera monitors the shift while the focus drive of the stand moves to compensate for the drift in real-time. Using ZEN imaging software, simply choose a focus strategy and set up your experiment: all compensation happens automatically in the background, without interfering with your acquisition.

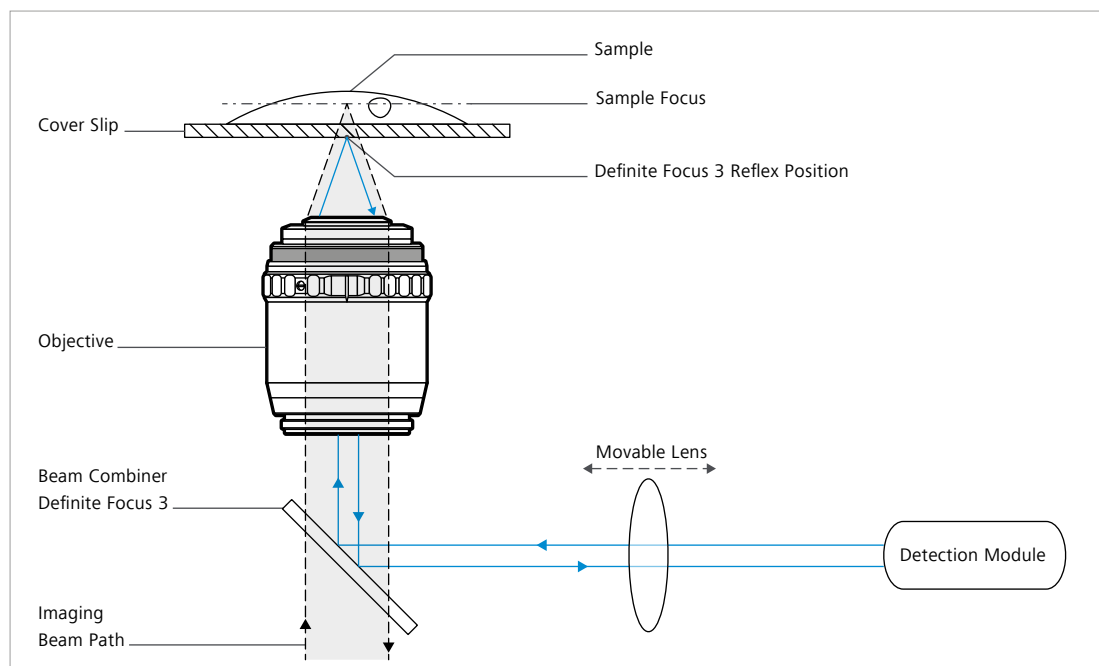

Schematic beam path of Definite Focus 3.



Definite Focus 3 is integrated into the nosepiece of your Axio Observer 7.

Your Insight into the Technology Behind It

- › In Brief
- › **The Advantages**
- › The Applications
- › The System
- › Technology and Details
- › Service

Efficient LED light sources for gentle fluorescence imaging

Your tasks in Life Sciences often require specific fluorescent labels. These labels need to be excited by exactly the right wavelength or even multiple wavelengths. Depending on the type of your experiments you also need stable and robust illumination to obtain reproducible data. LEDs convert electrical power into light more efficiently than other light sources. In comparison, they consume approximately 80 % less energy and do so over extremely long lifetimes. You will never again have to change a metal halide-, Xenon or Mercury-arc lamp. This saves you both money and time and protects the environment, too.



Xylys LED light source allows you to get a high and reproducible light output without warm-up times over the entire life span.

Depending on the model organism or cell line you are investigating, you will face many possible spectral combinations. That calls for high spectral flexibility in the fluorescence beam path. To observe fast processes in living samples, you need a system that can alter the imaging conditions rapidly.

Axio Observer uses advanced Virtual Filter technology: a dual filter wheel for emission filters and dichroics that enables flexible combinations of wavelengths. Combine it with any white light



Virtual Filters allow a wealth of excitation and emission combinations for fluorescence imaging.

source and the fast excitation filter wheel or use the unique multicolor Colibri LED light source to get all the benefits of high efficiency filters, full spectral flexibility, high excitation intensity and extremely fast switching times.



Excitation filter wheel for high speed multicolor imaging.

Expand Your Possibilities

- › In Brief
- › **The Advantages**
- › The Applications
- › The System
- › Technology and Details
- › Service

Use fast, gentle and reproducible

LED illumination – with Colibri

Fluorescence microscopy calls for a light source that produces just the right wavelength and enough intensity to excite the fluorescent dyes and proteins in your samples. That makes Colibri 5 and Colibri 7 with their fast LED illumination system the perfect choice for all your fluorescence imaging. Narrow-band LED excitation reduces cross-stimulation while increasing the contrast and SNR of your images. The LEDs are ideal for gentle live cell imaging: they only emit light within a narrow part of the spectrum and have no unwanted, cell-damaging UV leakage. Colibri is fully

integrated into ZEN imaging software, giving you the benefit of extremely fast switching times. Using a calibration diode, Colibri automatically measures and calibrates the light output of the diodes, resulting in reproducible excitation intensities over its entire life span. The LEDs can be turned on and off in microseconds with precise control of excitation intensities to protect your sample. This makes your imaging fast, and saves lamp live, as they are switched off instantly, whenever acquisition is paused.

Your Colibri light source can house LEDs with a broad variety of wavelengths and intensities. Colibri 7 gives you seven individually adjustable excitation wavelengths. With Colibri 5, you can use up to four different LEDs for fluorescence excitation of your sample. You always get enough excitation power to shorten exposure times and to speed up your image acquisition, if necessary. Choose the ideal configuration to exactly match your applications and budget.

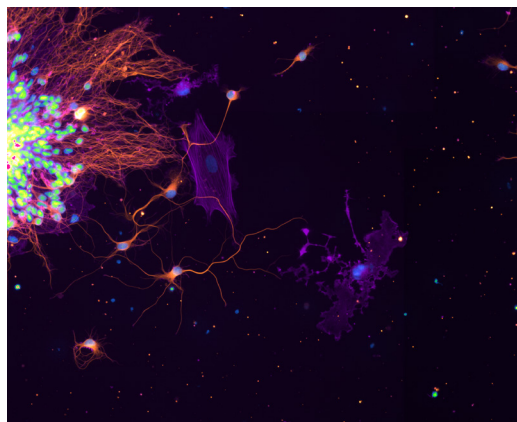

Primary cultures of rodent hippocampal neurons, stained for microtubules (orange), actin (purple) and nuclei (blue-green).
Courtesy of A. Patil, Drexel University College of Medicine, USA



Colibri 7 mounted to stand for full intensity – adjustment free and without an aging light guide.

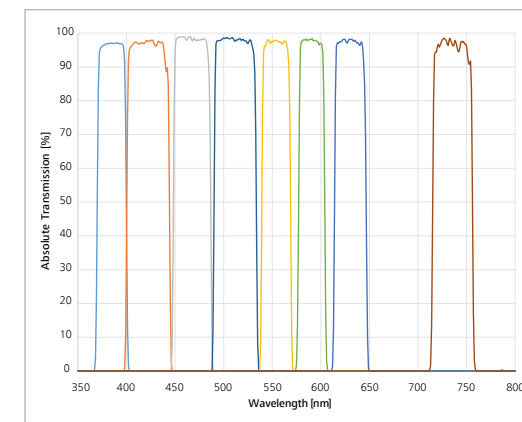

Colibri allows you to specifically excite fluorophores over the entire spectral range from UV to far red.

Expand Your Possibilities

- › In Brief
- › **The Advantages**
- › The Applications
- › The System
- › Technology and Details
- › Service

Automated, hands-free water immersion for reliable data acquisition from start to finish

Immersion media between the sample and the objective is required for high-resolution imaging. This can be a challenge for some experiments using water as immersion media. With automated multi-position data acquisition, one application of immersion media might not be sufficient as the sample moves to different locations. With live sample experiments, immersion water can evaporate over long periods. Manual addition of immersion media risks loss of data points or even microscope damage from user error; it is also tedious and inefficient. The Autoimmersion Module for ZEISS Axio Observer 7 widefield and confocal systems is your automated, easy-to-use solution for maintaining immersion media for water immersion objectives.



Improve your efficiency and throughput

With the ZEISS Autoimmersion Module, you can design complex experiments for unsupervised data collection where previously you were committed to stay near the microscope to ensure there was always enough immersion media. This includes extended live cell imaging experiments and / or multi-position data acquisition. Dedicate your time to other projects while your microscope collects data autonomously. Set up imaging acquisition during non-working hours, knowing that the ZEISS Autoimmersion Module will enable reliable data collection through the end of your experiment.

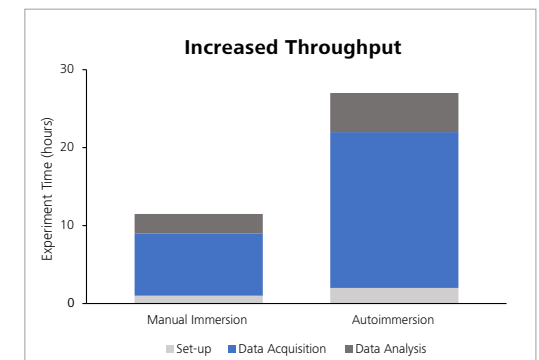

Improve your throughput by up to 2.5-fold by designing experiments that collect data during non-working hours, such as overnight or over the weekend.

Expand Your Possibilities

- › In Brief
- › **The Advantages**
- › The Applications
- › The System
- › Technology and Details
- › Service

Open Application Development (OAD) is your interface to the ZEN imaging software

- Use Python scripts to customize and automate your workflows.
- Integrate external image analysis applications into your workflows.
- Exchange image data with external programs like ImageJ, Fiji, MATLAB, KNIME or Python.
- Use feedback functions for smarter and dynamic experiments
- Get more reliable data in less time.
It's your choice.



OAD enables the analysis of data acquired with ZEN imaging software by other programs like ImageJ. Transfer your results back to ZEN for further analysis and display.

Expand Your Possibilities

- › In Brief
- › **The Advantages**
- › The Applications
- › The System
- › Technology and Details
- › Service

As your needs grow, you can always expand your Axio Observer. The flexible platform concept provides numerous defined and well documented interfaces. Upgrade new accessories from a broad portfolio of ZEISS solutions or third party offerings.



Choose the right objectives for your application from a broad portfolio of lenses.



Use Duolink and ZEN imaging software to perform high speed imaging with two spectrally separated channels simultaneously.

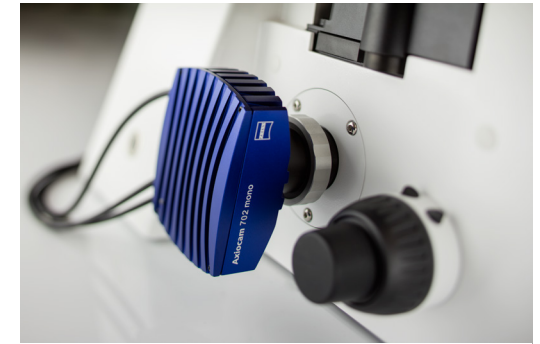

Select a microscope camera with the sensitivity, resolution and imaging speed you need.



Expand your system with a range of complementary 3D imaging methods.



Combine your Axio Observer with stable incubation options for long-term live cell imaging.



Create long-term live cell and multi-position experiments with automated water immersion.

Tailored Precisely to Your Applications

- › In Brief
- › The Advantages
- › **The Applications**
- › The System
- › Technology and Details
- › Service

Typical Applications	Task	ZEISS Axio Observer offers
Label-free live cell cultures	Evaluate and document cell culture status	<ul style="list-style-type: none"> ■ PlasDIC contrast for high-resolution images through plastic vessels ■ Objectives with long working distance and correction rings to enhance contrast and resolution ■ Sample carriers and stages for large cell culture flasks ■ Large field of view imaging (field number: 23 mm)
Transfected live cell cultures	Evaluate and document transfection rate and transfection stability	<ul style="list-style-type: none"> ■ Gentle fluorescence excitation by Colibri 5 and 7
Label-free fixed and thin tissue slices or small organism	Document and evaluate cell and tissue morphology and growth state	<ul style="list-style-type: none"> ■ Optimized DIC for low magnification, high numerical aperture multi-immersion lenses
Reproductive or adherent cells and cell cultures	Mechanical manipulation of cells (e.g. injection of germ cells), injection of dyes and other biologically active substances	<ul style="list-style-type: none"> ■ Phase contrast, improved Hoffmann Modulation contrast (HMC), DIC contrast ■ Support for micromanipulators from Narishige, Eppendorf and Luigs & Neumann ■ Heated microscope stage and mounting frames, heating inserts
Living neuronal or muscular cell culture or tissue slices	Observation of fast densitometric, ratiometric and electrical signals	<ul style="list-style-type: none"> ■ Water- and silicon oil immersion objectives; Autoimmersion Module ■ Apochromatic and UV-enhanced reflected-light illuminator ■ Double camera adapter Duolink ■ Highspeed filter wheels and shutters ■ Fast multicolor LED illumination with Colibri 5 and 7 ■ High efficiency filter sets ■ Z-PIEZO (500 µm) with large travel range
Fixed immunofluorescence labelled tissue or cell culture samples	Identification, quantification and qualification of cell types, cell-, tissue and protein markers in 2D and 3D samples	<ul style="list-style-type: none"> ■ Definite Focus 3 ■ Dual filter wheel ■ Apotome 3 ■ Piezo stage for high speed, high precision XY positioning ■ Various mounting frames for different sample carriers
Multi-labelled living tissue section, organs, organotypic-, spheroid or cell culture preparations	Long-term observation of physiological and morphological parameters in 2D/3D	<ul style="list-style-type: none"> ■ Autocorr objectives ■ Definite Focus 3 ■ Special objectives for incubation ■ Life cell imaging objectives ■ Long distance objectives ■ Water and silicone oil immersion objectives; Autoimmersion Module ■ Aqua Stop II ■ Incubation, CO₂ and O₂ control ■ Camera adapter for large field of view imaging (field number: 23 mm) ■ Colibri 5 and 7
Microbiomes, bacteria and yeast cultures	Identification and characterisation of cell wall, cell cycle and host-parasite interaction	<ul style="list-style-type: none"> ■ C-Apochromat 100×/1.25 W Corr ■ Plan-Apochromat 150×/1.35 Glyc DIC Corr

ZEISS Axio Observer at Work

- › In Brief
- › The Advantages
- › **The Applications**
- › The System
- › Technology and Details
- › Service

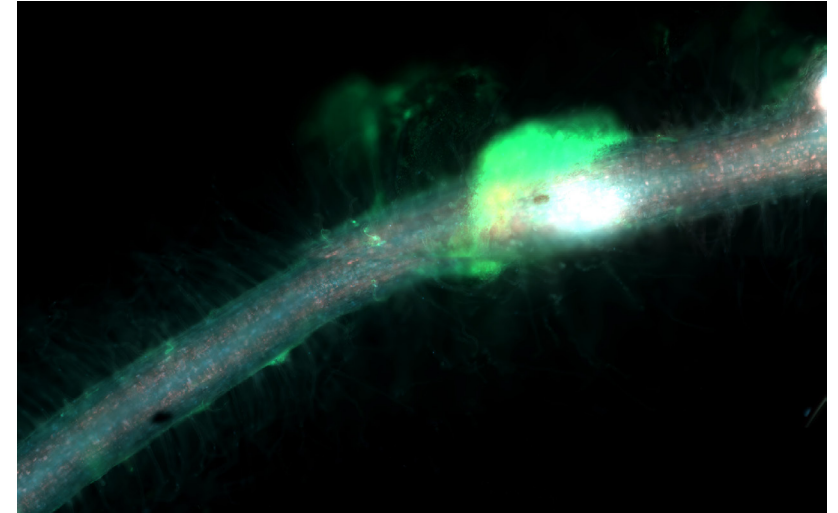
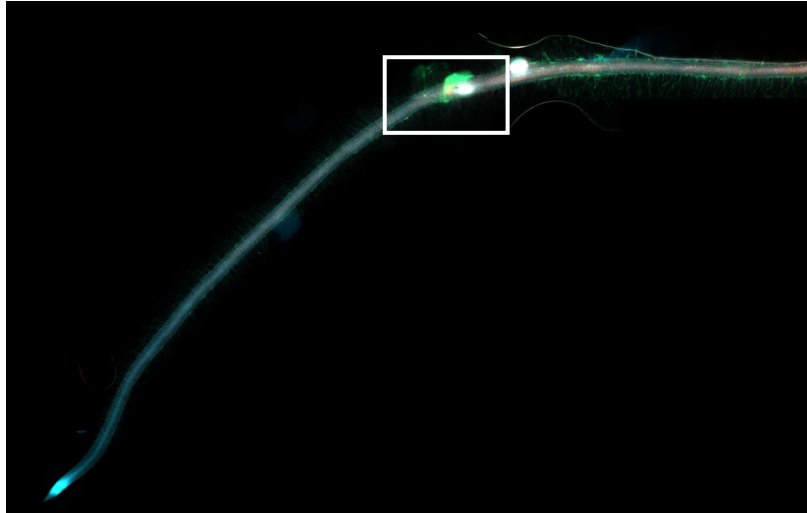

*Autofluorescence of a Lotus Japonicus root infected with symbiotic bacteria stained with mcherry.
Courtesy of F.A. Ditengou, University of Freiburg, Germany.*

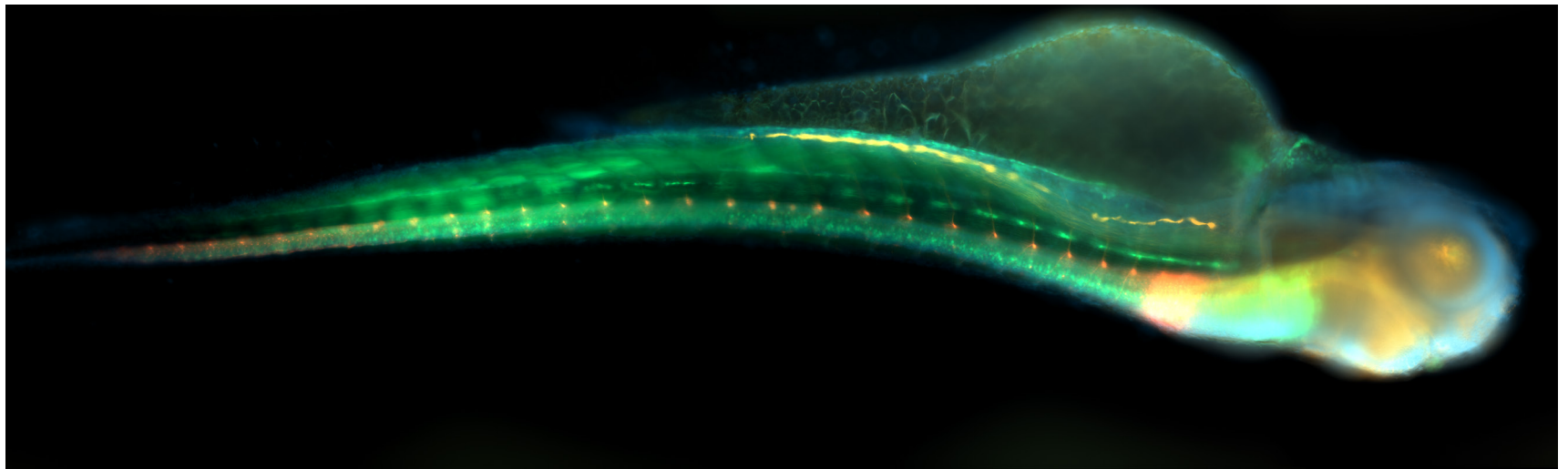

*Transgenic zebrafish larvae at 4 days post fertilization staining for: Glial fibrillary acidic protein, acetylated Tubulin, GFP and DNA. Embedded in 1.2% low melt agarose.
Courtesy of H. Reuter, Leibniz-Institute on Aging – Fritz-Lipmann-Institut e.V. (FLI), Germany.*

ZEISS Axio Observer at Work

- › In Brief
- › The Advantages
- › **The Applications**
- › The System
- › Technology and Details
- › Service

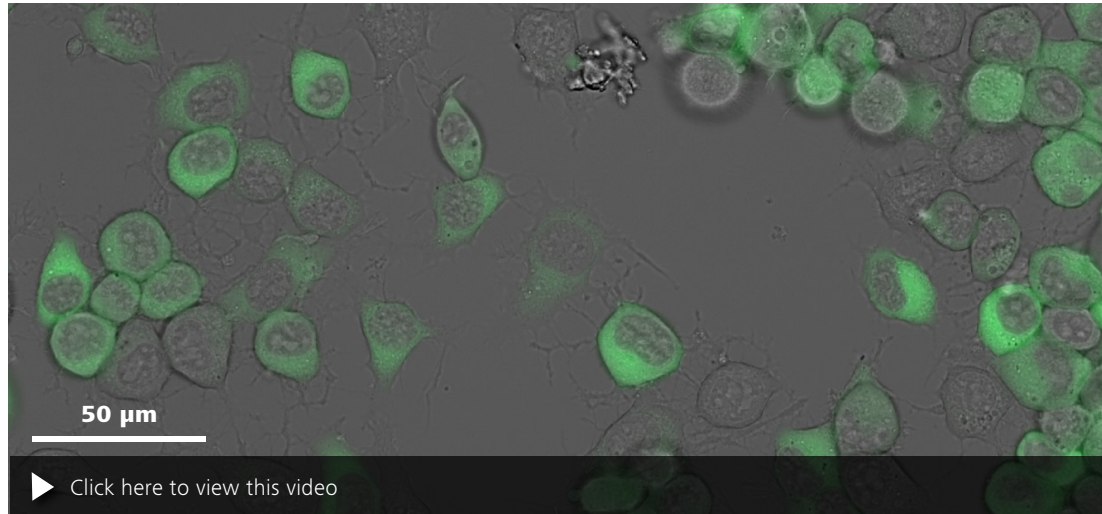

HeLa cell culture with cytosolic eGFP. Proliferation imaged over 16 hours.

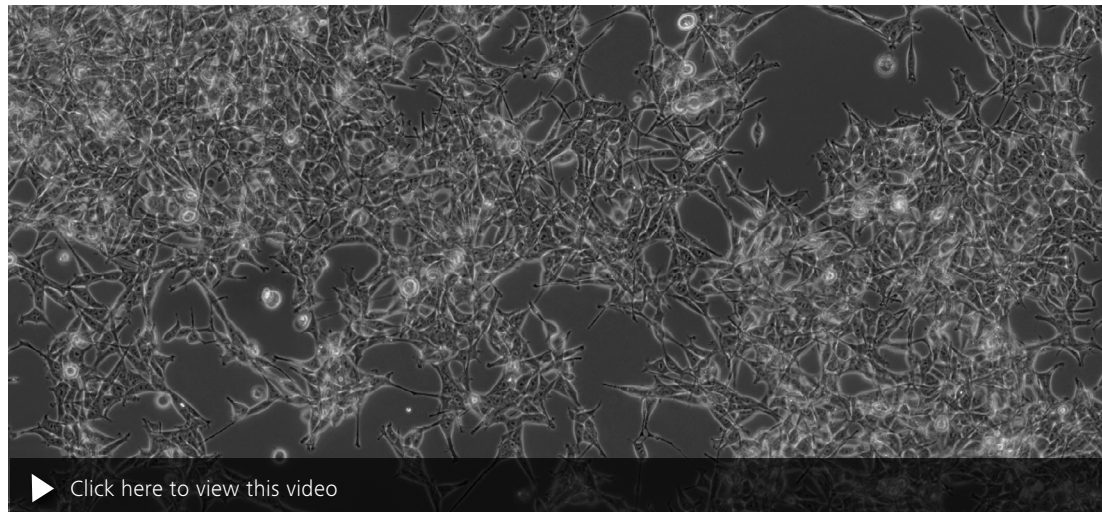

HEK 293 cells. Long-term time lapse recording of 3 × 3 tiles with 240s interval. Acquired with Axiacam 506 mono, stabilized by Definite Focus 3 at 10s interval.

ZEISS Axio Observer at Work

- › In Brief
- › The Advantages
- › **The Applications**
- › The System
- › Technology and Details
- › Service

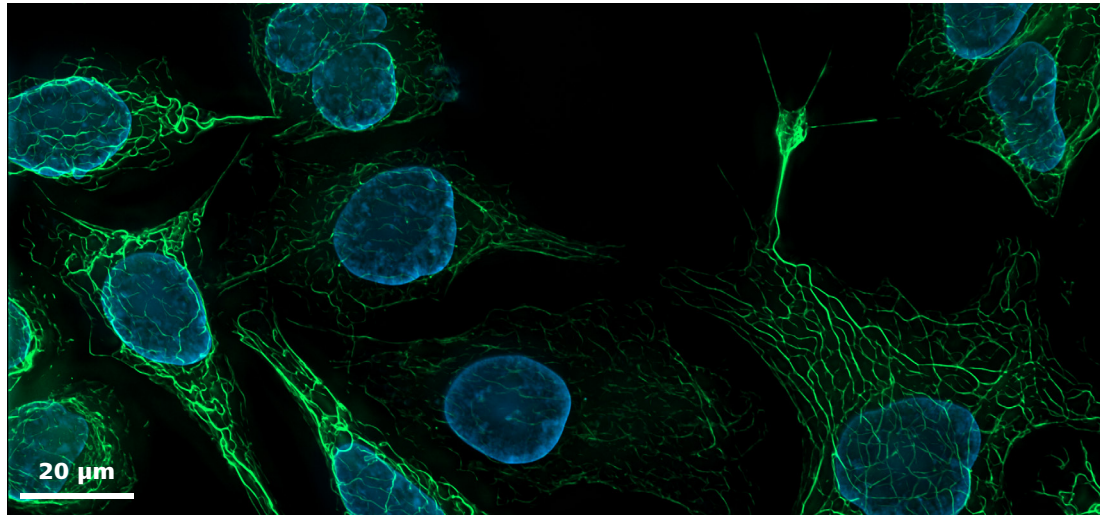

SK8 K18 mouse cells. Vimentin stained with Alexa 488 (green), nuclei stained with DAPI (blue).

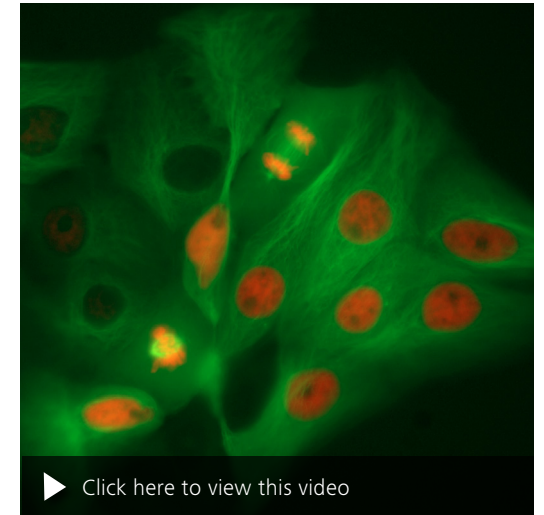

LLC PK1 cells. Time lapse recording of undisturbed cell division.

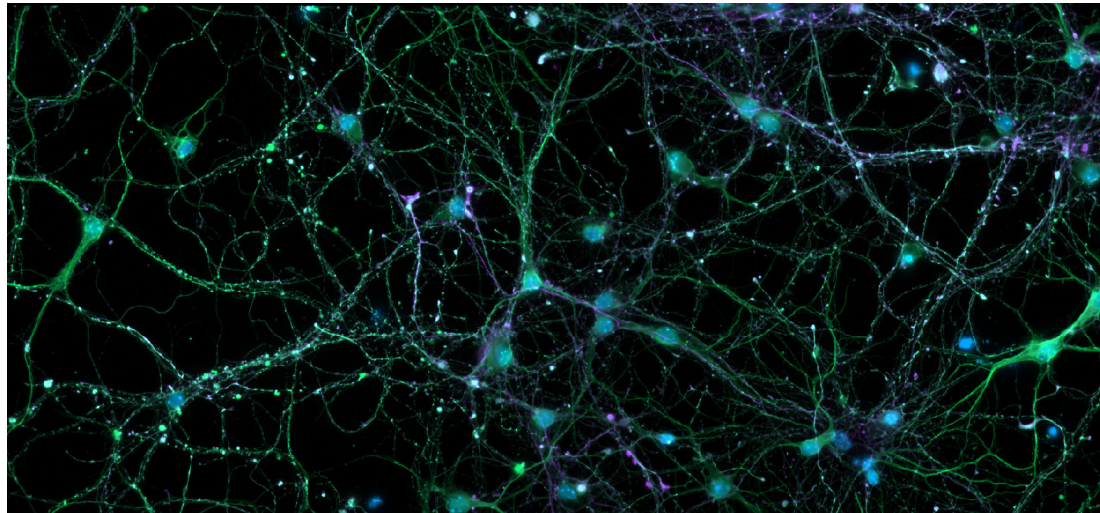

Cortical neurons stained for DNA, microtubules and microtubule-associated proteins.
Courtesy of L. Behrendt, Leibniz-Institute on Aging – Fritz-Lipmann-Institut e.V. (FLI), Germany.

ZEISS Axio Observer at Work

- › In Brief
- › The Advantages
- › **The Applications**
- › The System
- › Technology and Details
- › Service

Live cell experiments over extended periods with automated immersion

HEK KO PEX5 cells expressing eGFP with a photocaged peroxisomal targeting signal type 1 were reconstituted with the peroxisomal import receptor PEX5. A light induced conformational change of the photocage leads to exposure of the peroxisomal targeting signal. If the WT PEX5 is expressed, accumulation of the eGFP signal in the dotted peroxisomes can be monitored (top row). In case of the mutated PEX5 (bottom row), even after 18 hours, no peroxisomal import could be detected.

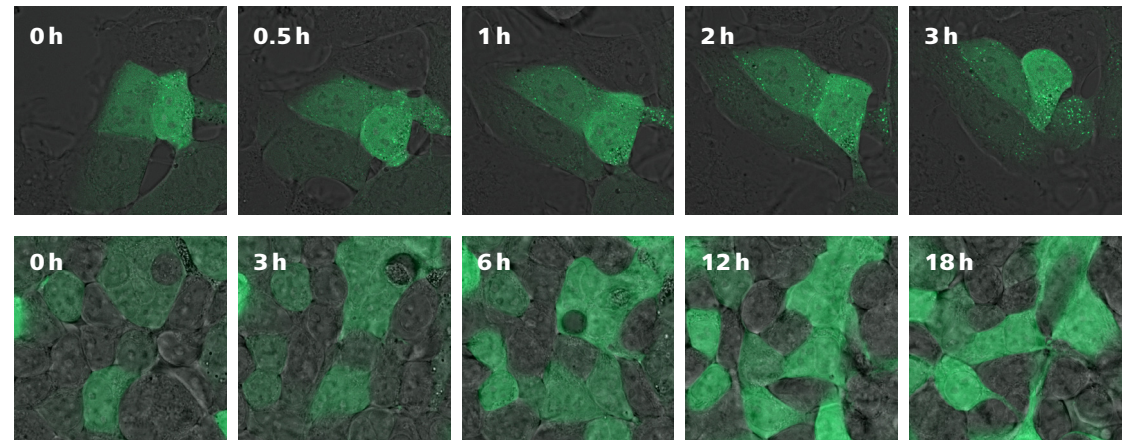

Sample courtesy of K. Reglinski, Institute for Applied Optics and Biophysics, Friedrich-Schiller-Universität Jena, Germany.

Multi-position, extended time lapse experiment with automated immersion

When working with living samples, you might not know where your event of interest may occur. To capture the uptake of nanoparticles by macrophages, many locations from a multi-well plate are acquired as well as multiple z-planes over several hours at 37°C using re-immersion. The region shown above is a subset of the much larger dataset that was captured using automated imaging and shows the uptake of nanoparticles inside the cells (top row). The surface of the cells were also imaged to verify that the nanoparticles are inside the cells and not simple sitting on the cell surface (bottom row).

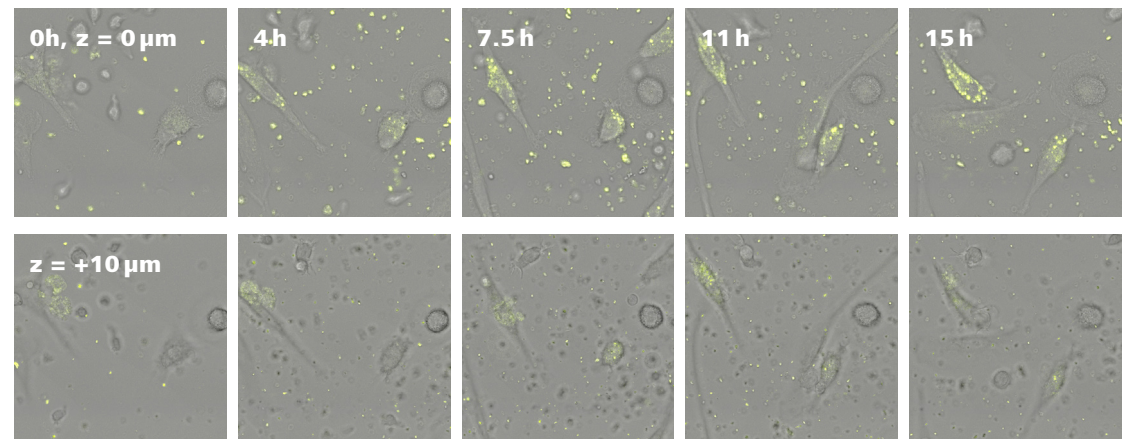

Sample courtesy: F. Páez Larios and C. Eggeling, Institute for Applied Optics and Biophysics, Friedrich-Schiller-Universität Jena, Germany.

ZEISS Axio Observer at Work

- › In Brief
- › The Advantages
- › **The Applications**
- › The System
- › Technology and Details
- › Service

Accurate data acquisition in aqueous samples

For researchers testing different sample conditions for a specimen, such as drug responses, or measuring a full binding isotherm by fluorescence correlation spectroscopy (FCS), using multi-well specimen holders and automated data collection can dramatically improve throughput and increase efficiency. However, acquiring accurate measurements is critical for these types of experiments.

The ZEISS Autoimmersion Module is both fast and exact, ensuring your data collection is accurate even when moving to multiple positions of a multi-well specimen. As shown on the right, researchers prepared wells with different concentrations of a fluorescently labeled protein and were able to accurately measure the binding curve to red fluorescent liposomes using fluorescence cross-correlation spectroscopy (FCCS).

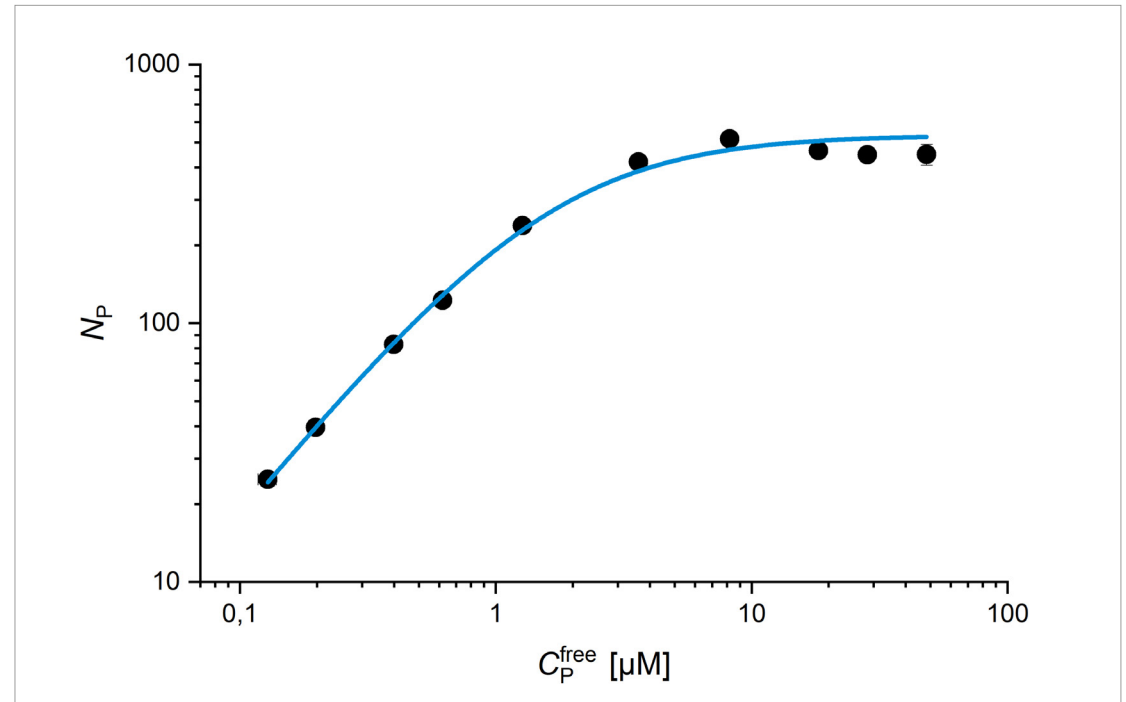

Red fluorescent small liposomes and different concentrations of Sar1p protein (partially labeled with Alexa Fluor 488) were mixed in a 96 multi-well plate and measured automatically over 15 hours. Krüger et al., Biophys. J. 2017. Sample courtesy of C. Haupt and K. Bacia, University of Halle, Germany

Your Flexible Choice of Components

- › In Brief
- › The Advantages
- › The Applications
- › **The System**
- › Technology and Details
- › Service



1 Microscope

- Axio Observer 3: manual stand with encoded components
- Axio Observer 5: manual stand with encoded nosepiece and encoded or motorized reflector turret
- Axio Observer 7: motorized stand with motorized Z-drive
- AI Sample Finder
- Light Manager and Contrast Manager
- Depending on stand version:
 - Manual, coded or motorized Optovar turret, available magnifications: 1.25x, 1.6x, 2.5x;
 - Manual, coded or motorized 6x reflector turret

2 Objectives

- C-Apochromat autocorr
- C-Apochromat
- LD LCI Plan-Apochromat autocorr
- Plan-Apochromat
- EC Plan-Neofluar
- LD A-Plan
- Temperature isolated i LCI Plan-Neofluar

3 Illumination

- UV/VIS Reflected Light Beampath for fluorescence with high speed shutter, Filter wheel excitation 8-pos. mot. for filters $d=25\text{ mm}$, CAN; Dual filter wheel mot. for beam splitting and emission, CAN; high efficiency filter sets
- Software controlled high-power LED white light source
- Fast multicolor LED illumination system Colibri 5 and 7
- Transmitted light beam path with manual or motorized condenser with long-working distance
- VIS-LED for fast acquisition
- Differential Interference Contrast (DIC), PlasDIC, Phase Contrast, improved Hoffman-Modulation Contrast (iHMC)

4 Imaging Systems

- Apotome 3
- LSM 900 with Airyscan 2
- LSM 980 with Airyscan 2
- Elyra superresolution systems

5 Accessories

- Broad incubation portfolio (heatable mounting frames, heating inserts, CO_2 and O_2 controller)
- High precision / high speed motorized scanning stages and a range of manual stages
- Z-PIEZO stage insert with $500\ \mu\text{m}$ travel range
- Adjustable dual camera adapter Duolink
- Autoimmersion Module
- All Axiocam microscope cameras and a wide range of high-end 3rd party cameras

6 Software

- ZEN (blue edition), recommended modules: Tiles & Positions, Experiment Designer, Physiology (Dynamics), Deconvolution, 3Dxl Viewer – powered by arivis®

System Overview

- In Brief
- The Advantages
- The Applications
- The System
- Technology and Details
- Service

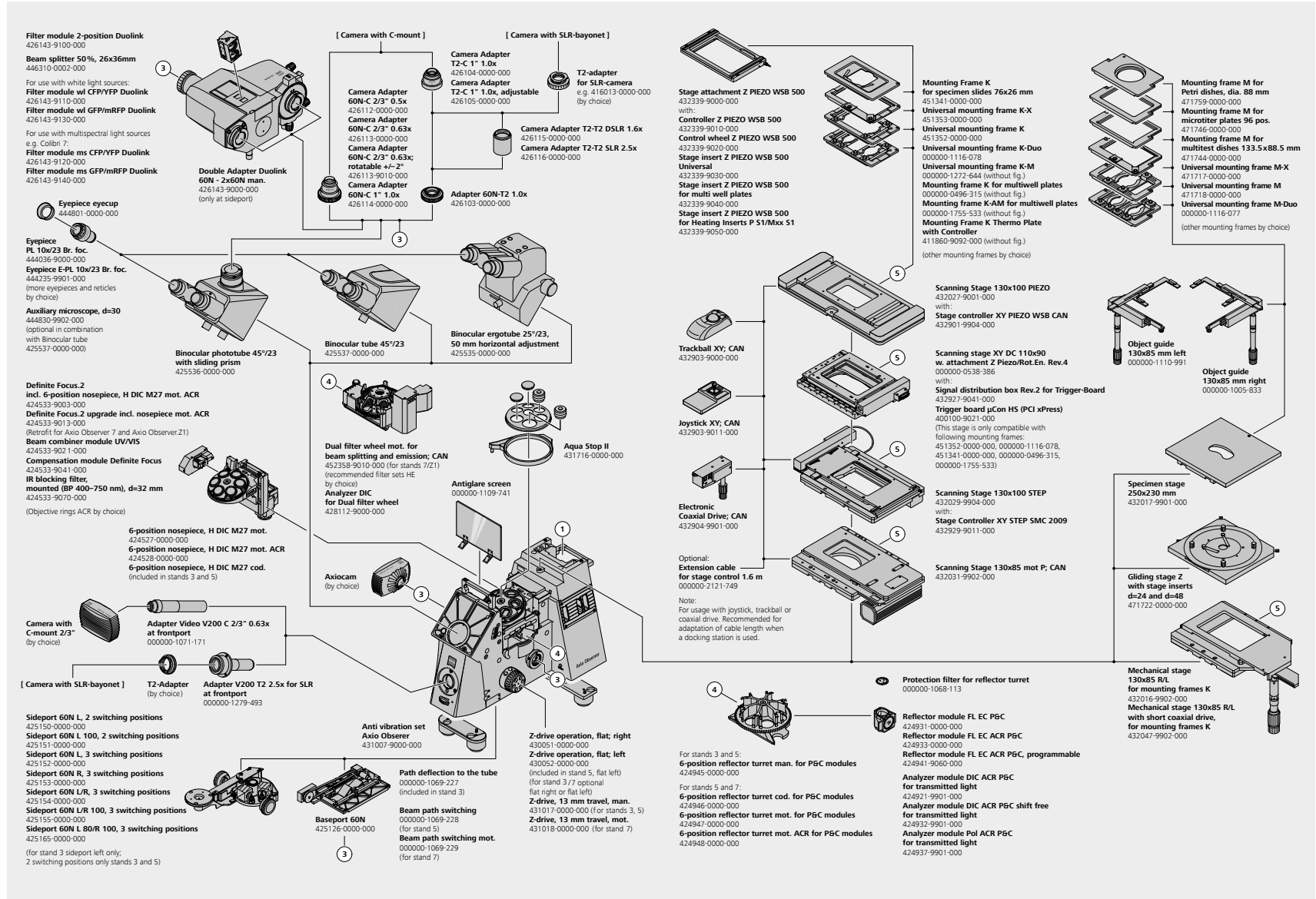

System Overview

- ▶ In Brief
- ▶ The Advantages
- ▶ The Applications
- ▶ The System
- ▶ Technology and Details
- ▶ Service

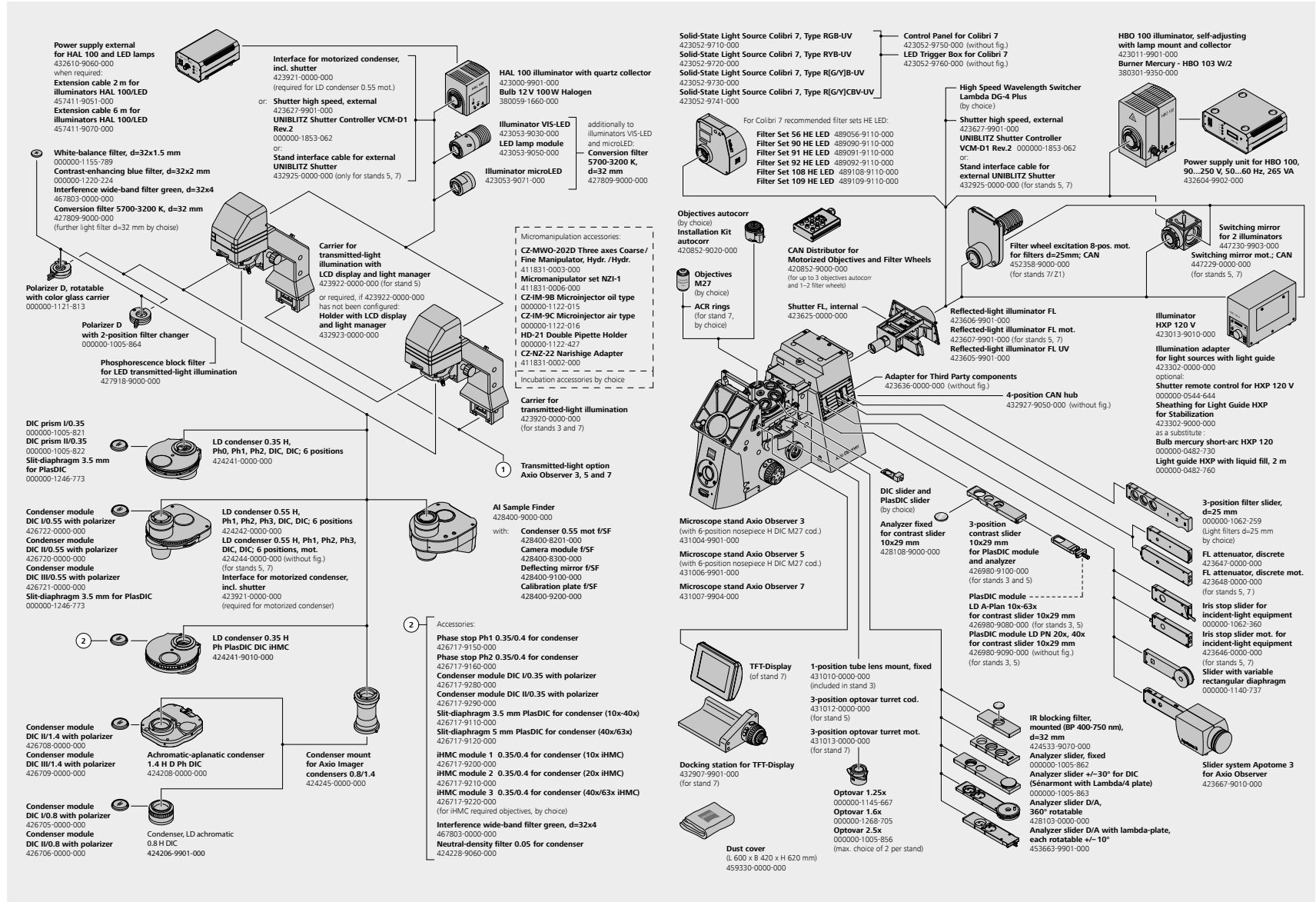

Technical Specifications

- › In Brief
- › The Advantages
- › The Applications
- › The System
- › **Technology and Details**
- › Service

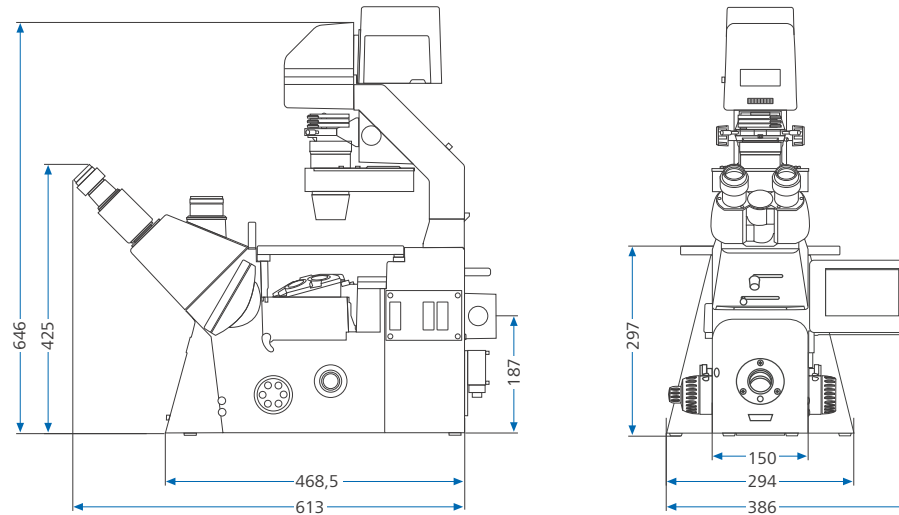

For more detailed information on dimensions please contact us at microscopy@zeiss.com

	Option	3	5	7
Stand	manual	+	+	-
	motorized	-	o*	+
Encoding	readable by PC	+	+	+
Display	LCD display	-	o**	-
	TFT display	-	-	+
	Docking station	-	-	o
Interfaces	CAN	+	+	+
	RS 232	-	+	+
	USB	+	+	+
	TCP/IP	-	+	+
	Socket for external UNIBLITZ shutter	-	+	+
	Trigger socket (In/Out) for shutter	-	+	+

+ = included in stand o = optionally available o* = optional: reflector turret mot., reflected-light illumination mot., LD condenser 0.55 mot.
o** = requirement (either Carrier transmitted-light illumination, LCD display, Shutter (423926-9010-00) or Holder with LCD display and Light Manager (432923-0000-000)) +*** = "simple" Light manager - = not available

Technical Specifications

- › In Brief
- › The Advantages
- › The Applications
- › The System
- › **Technology and Details**
- › Service

Option		3	5	7
4-position CAN hub		–	o	o
Light manager		+***	+	+
Contrast manager		–	–	+
Circular operation key unit	right	–	+	+
	left	–	–	+
Z-focus drive	manual	+	+	–
	motorized, stepper motor drive (z-step size 10 nm)	–	–	+
Adjustable limit stop for z-focus	manual	–	+	–
Automatic Component Recognition (ACR)	Nosepiece ACR	–	–	o
	Reflector turret ACR	–	o	o
Power supply	internal	+	+	–
	external	–	–	+
Z-drive operation (flat control knob)	right	o	–	o
	left	o	+	o
Z-drive, 13 mm extended travel range	manual	o	o	–
	motorized	–	–	o
Nosepiece	6-pos. H DIC cod.	+	+	–
	6-pos. H DIC mot.	–	–	o
	6-pos. H DIC mot. ACR	–	–	o
Definite Focus 3	incl. nosepiece 6-pos. H DIC mot. ACR	–	–	o
Objectives autocorr		–	–	o
Contrast methods transmitted light	PlasDIC	o	o	o
	PlasDIC with contrast slider	o	o	–
Tube lens mount, fixed/Optovar turret	1-pos. tube lens mount, fixed	+	o	o
	3-pos. optovar turret, encoded	–	o	–
	3-pos. optovar turret, motorized	–	–	o

+ = included in stand o = optionally available o* = optional: reflector turret mot., reflected-light illumination mot., LD condenser 0.55 mot.

o** = requirement (either Carrier transmitted-light illumination, LCD display, Shutter (423926-9010-00) or Holder with LCD display and Light Manager (432923-0000-000)) +*** = "simple" Light manager – = not available

Technical Specifications

- › In Brief
- › The Advantages
- › The Applications
- › The System
- › **Technology and Details**
- › Service

	Option	3	5	7
Sideport (type)	2 or 3-pos. man. (exit to the left only)	+	–	–
	2 or 3-pos. man. L/R	–	+	–
	3-pos. mot. L/R	–	–	+
Sideport (accessory)	60N L, 2 switching positions (100% vis : 0% L / 20% vis : 80% L)	o	o	–
	60N L 100, 2 switching positions (100% vis : 0% L / 0% vis : 100% L)	o	o	–
	60N L, 3 switching positions (100% vis : 0% L / 0% vis : 100% L / 50% vis : 50% L)	o	o	o
	60N R, 3 switching positions (100% vis : 0% R / 0% vis : 100% R / 50% vis : 50% R)	–	o	o
	60N L/R 3 switching positions (100% vis : 0% LR / 0% vis : 100% L / 20% vis : 80% R)	–	o	o
	60N R/L 100, 3 switching positions (100% vis : 0% LR / 0% vis : 100% L / 0% vis : 100% R)	–	o	o
	60N L 80/R 100, 3 switching positions (100% vis : 0% LR / 20% vis : 80% L / 0% vis : 100% R)	–	o	o
Path deflection to the tube (VIS only)		+	o	o
Beam path switching (for VIS / frontport / baseport)	manual	–	o	–
	motorized	–	–	o
Baseport / Frontport		–	o	o
Scanning stages	Scanning Stage 130×85 mot; CAN	o	o	o
	Scanning Stage 130×100 STEP	o	o	o
	Scanning Stage 130×100 PIEZO	o	o	o
	Scanning Stage XY DC 110×90 with attachment Z Piezo/Rot.En.	o	o	o
Stage attachment Z PIEZO		o	o	o
Carrier transmitted-light illumination	without LCD display	o	–	o
	with LCD display	–	o**	–
Illuminator transmitted-light	microLED 2, VIS-LED, HAL 100	o	o	o
Condensers	LD 0.35 / LD 0.55, manual	o	o	o
	LD 0.55, motorized	–	o	o
	LD condenser 0.55, motorized; AI Sample Finder	–	–	o
Shutter for transmitted-light	internal	–	o	o
	external, High Speed (with int. controller)	–	o	o

+ = included in stand o = optionally available o* = optional: reflector turret mot., reflected-light illumination mot., LD condenser 0.55 mot.

o** = requirement (either Carrier transmitted-light illumination, LCD display, Shutter (423926-9010-00) or Holder with LCD display and Light Manager (432923-0000-000)) +*** = "simple" Light manager – = not available

Technical Specifications

- › In Brief
- › The Advantages
- › The Applications
- › The System
- › **Technology and Details**
- › Service

	Option	3	5	7
Reflected light illumination	manual	o	o	o
	motorized	–	o	o
Slider for reflected light illumination	manual	o	o	o
	motorized	–	o	o
Shutter for reflected light	Shutter FL, internal	o	o	o
	High Speed, external (with int. controller)	–	o	o
Illumination system	HBO 100, HXP 120 V, Colibri 5 and 7, Xylis LED (white light LED)	o	o	o
Reflector turret	6-pos. manual	o	o	–
	6-pos. encoded	–	o	o
	6-pos. motorized	–	o	o
	6-pos. motorized ACR	–	o	o
Fast filter wheels	Dual filter wheel mot. for beam splitting and emission; CAN	–	–	o
	Filter wheel excitation 8-pos. mot. for filters d=25 mm; CAN	–	–	o
Switching mirror mot.; CAN	motorized	–	o	o
Laser safety upgradeable		–	–	o
Apotome 3		–	o	o

o = optionally available – = not available

ZEISS Service – Your Partner at All Times

Your microscope system from ZEISS is one of your most important tools. For over 170 years, the ZEISS brand and our experience have stood for reliable equipment with a long life in the field of microscopy. You can count on superior service and support - before and after installation. Our skilled ZEISS service team makes sure that your microscope is always ready for use.

- › In Brief
- › The Advantages
- › The Applications
- › The System
- › Technology and Details
- › **Service**

Procurement

- Lab Planning & Construction Site Management
- Site Inspection & Environmental Analysis
- GMP-Qualification IQ/OQ
- Installation & Handover
- IT Integration Support
- Startup Training

Operation

- Predictive Service Remote Monitoring
- Inspection & Preventive Maintenance
 - Software Maintenance Agreements
 - Operation & Application Training
 - Expert Phone & Remote Support
 - Protect Service Agreements
 - Metrological Calibration
 - Instrument Relocation
 - Consumables
 - Repairs

New Investment

- Decommissioning
- Trade In

Retrofit

- Customized Engineering
- Upgrades & Modernization
- Customized Workflows via APEER



Please note: Availability of services depends on product line and location

>> www.zeiss.com/microservice



Carl Zeiss Microscopy GmbH

07745 Jena, Germany
microscopy@zeiss.com
www.zeiss.com/axio-observer